

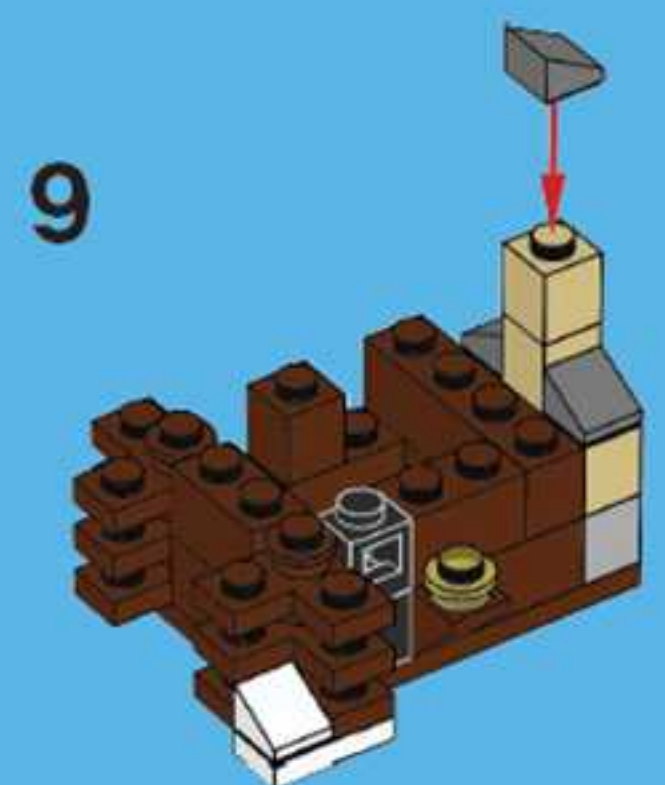

40062

Ages/edades
6+

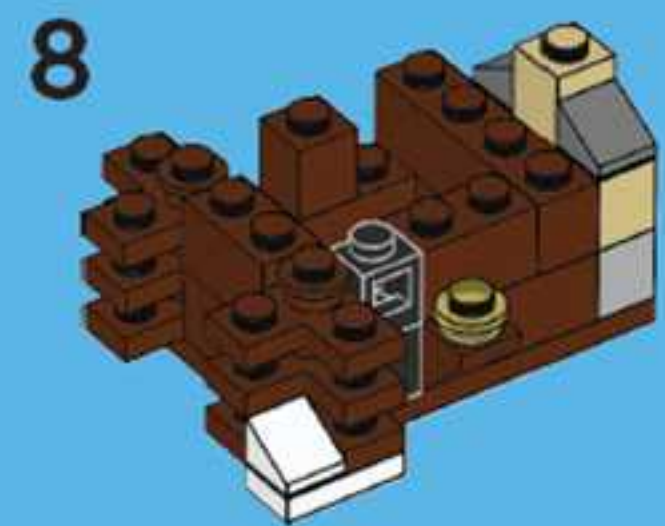

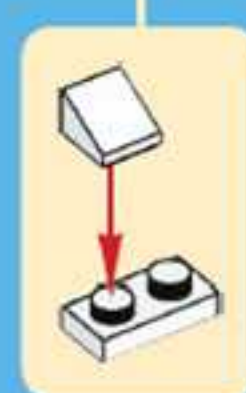
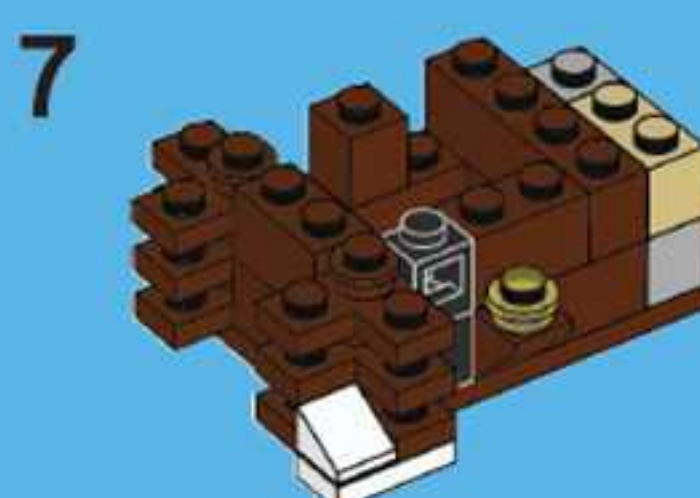
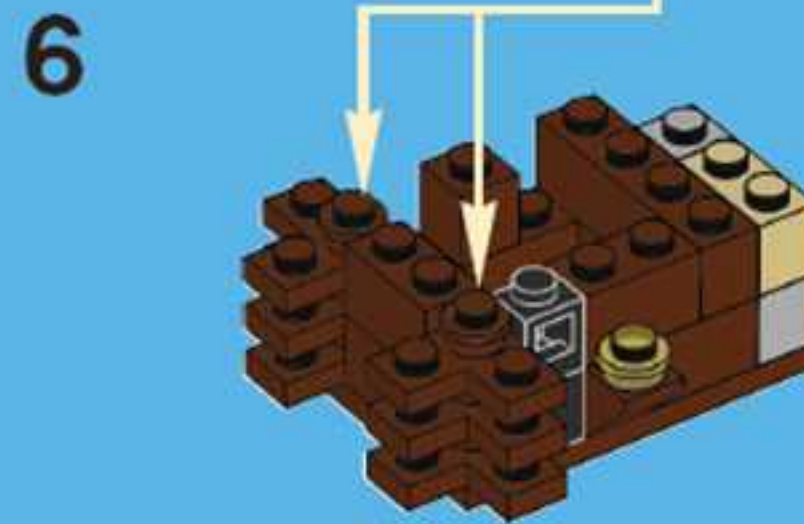
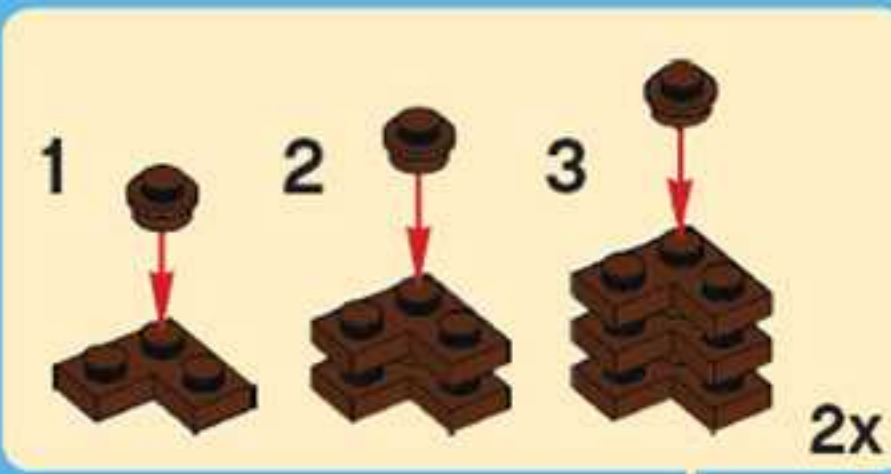
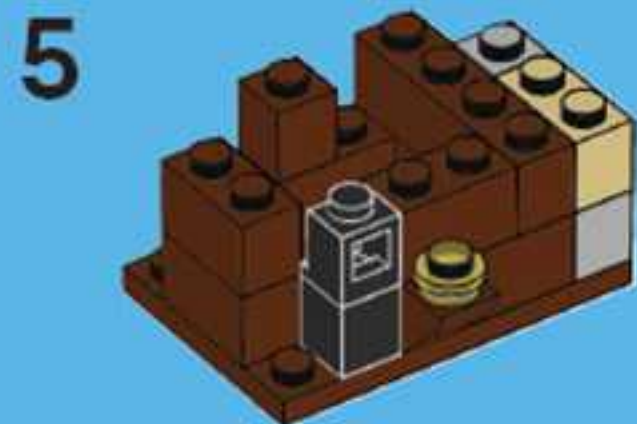
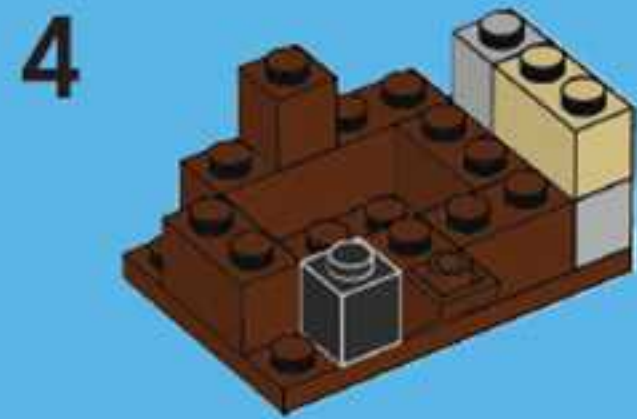
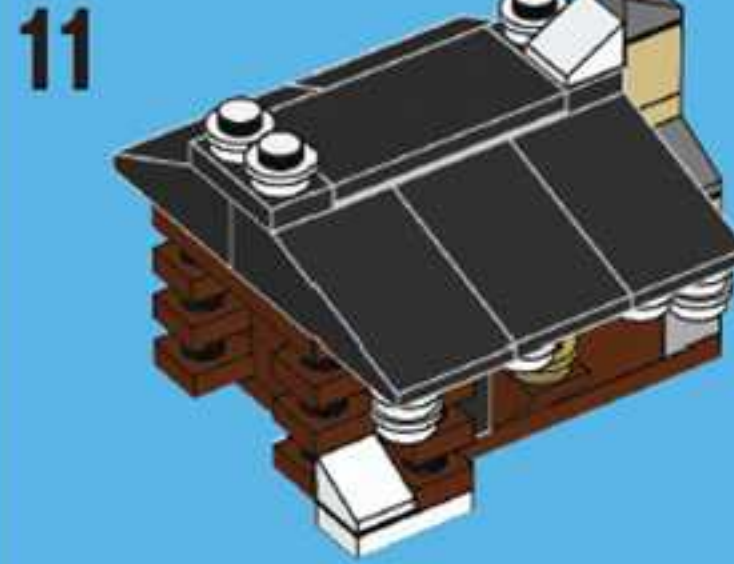
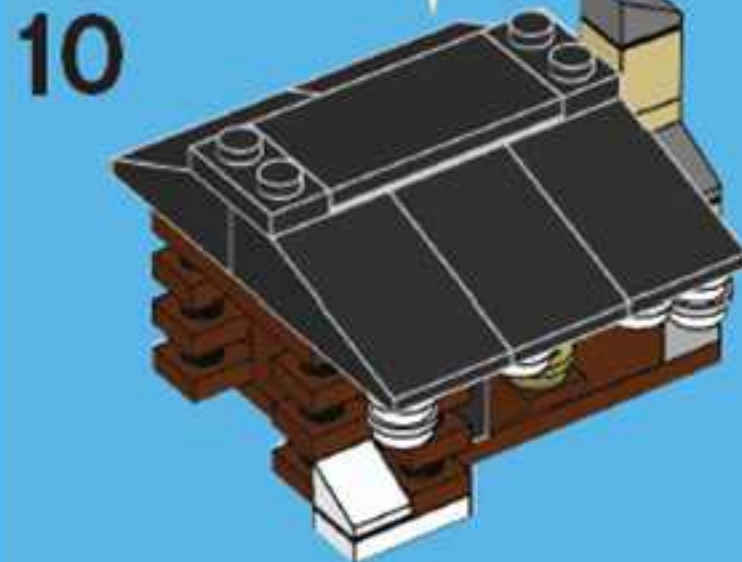
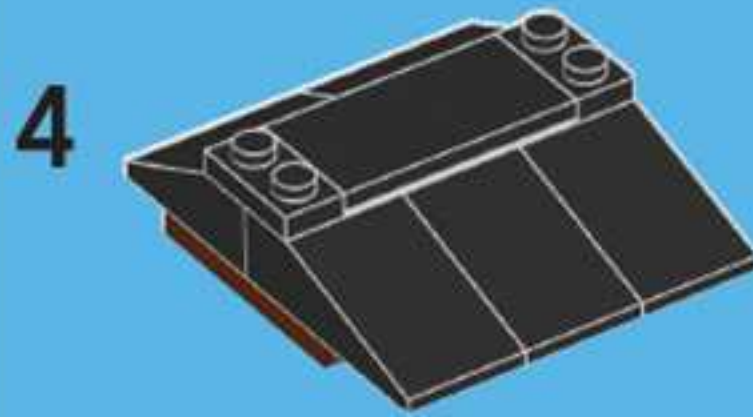
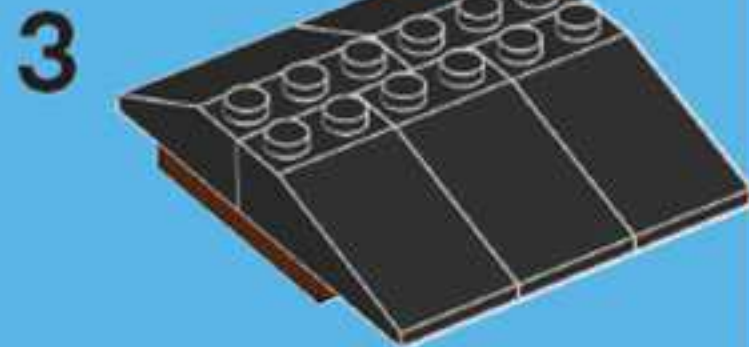
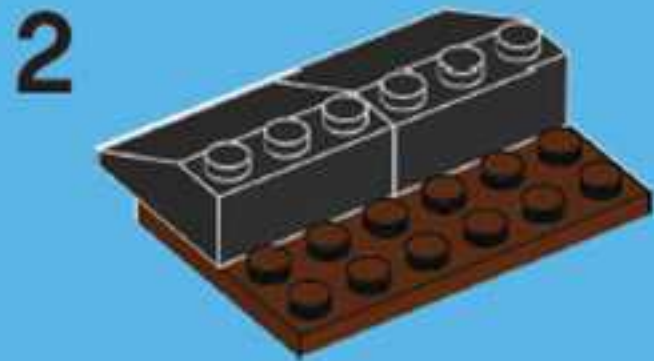
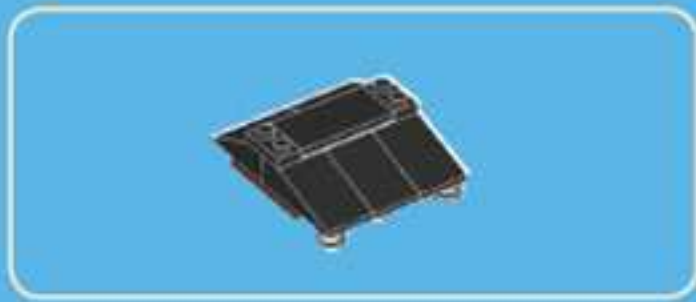

- | | | | |
|---------------|---------------|---------------|---------------|
| 1x
300526 | 2x
4211225 | 2x
416126 | 2x
4113915 |
| 2x
302326 | 1x
4211222 | 3x
4185583 | 2x
4109995 |
| 1x
4560182 | 6x
4211257 | 2x
4504369 | 1x
3005744 |
| 6x
4216581 | 2x
4271874 | 1x
302301 | 2x
4211389 |
| 1x
4211242 | 1x
407026 | 13x
614101 | 3x
4504378 |
| 5x
4211149 | | | |

Warning! Choking hazard. Small parts.
 Achtung! Erstickungsgefahr. Kleinteile.
 Attention ! Risque d'étouffement. Petites pièces.
 Avvertenza! Pericolo di soffocamento. Parti piccole.
 Waarschuwing! Verstikkingsgevaar. Kleine deeltjes.
 Advertencia! Riesgo de asfixia. Piezas pequeñas.
 Advarsel! Kvælningsfare. Små dele.
 Varoitus! Tukehtumisvaara. Pieniä osia.
 Varning! Kvävningrisk. Små delar.
 Atenção! Perigo de asfixia. Peças pequenas.
 Προσοχή! Κίνδυνος πνιγμού. Μικρά κομμάτια.
 警告! 窒息の危険性。小さな部品。
 警告! 小心窒息。当心小物件。
 경고! 질식사 위험. 작은 부품 포함.

Внимание! Риск удушья. Маленькие детали.
 Ostrzeżenie! Zagrożenie zadławieniem. Małe elementy.
 Upozornění! Nebezpečí udušení. Malé součástky.
 Upozorenje! Nebezpečnost udusenja. Male sūcasti.
 Figyelmeztetés! Fulladásveszély! Kis elemek.
 Обережно! Ризик задухи. Дрібні деталі.
 Upozorenje! Opasnost od gušenja. Sitni dijelovi.
 Upozorenje! Opasnost od gušenja. Mali delovi.
 Oporozorje! Nevarnost zadužitve. Majhni delčki.
 Avertisment! Pericol de sufocare. Piese mici.
 Внимание! Опасность от задуяеня. Малки части.
 Bīdinājums! Aizrīšanas risks. Sīkas daļas.
 Hoitus! Lambumisoht. Väiksed osad.
 Ispejmasi! Uždusimo pavojus! Mažos detalės.
 Dikkat! Boğulma tehlikesi. Küçük parçalar.

